

SHURE®

LEGENDARY
PERFORMANCE™



BLX Wireless Microphone System
Système de microphone sans fil BLX
Sistema de micrófonos inalámbricos BLX
Sistema de Microfone Sem Fio BLX



IMPORTANT SAFETY INSTRUCTIONS

1. READ these instructions.
2. KEEP these instructions.
3. HEED all warnings.
4. FOLLOW all instructions.
5. DO NOT use this apparatus near water.
6. CLEAN ONLY with dry cloth.
7. DO NOT block any ventilation openings. Allow sufficient distances for adequate ventilation and install in accordance with the manufacturer's instructions.
8. DO NOT install near any heat sources such as open flames, radiators, heat registers, stoves, or other apparatus (including amplifiers) that produce heat. Do not place any open flame sources on the product.
9. DO NOT defeat the safety purpose of the polarized or grounding-type plug. A polarized plug has two blades with one wider than the other. A grounding type plug has two blades and a third grounding prong. The wide blade or the third prong are provided for your safety. If the provided plug does not fit into your outlet, consult an electrician for replacement of the obsolete outlet.
10. PROTECT the power cord from being walked on or pinched, particularly at plugs, convenience receptacles, and the point where they exit from the apparatus.
11. ONLY USE attachments/accessories specified by the manufacturer.
12. USE only with a cart, stand, tripod, bracket, or table specified by the manufacturer, or sold with the apparatus. When a cart is used, use caution when moving the cart/apparatus combination to avoid injury from tip-over.
13. UNPLUG this apparatus during lightning storms or when unused for long periods of time.



14. REFER to the service to a qualified service personnel. Servicing is required when the apparatus has been damaged in any way, such as power supply cord or plug is damaged, liquid has been spilled or objects have fallen into the apparatus, the apparatus has been exposed to rain or moisture, does not operate normally, or has been dropped.
15. DO NOT expose the apparatus to dripping and splashing. DO NOT put objects filled with liquids, such as vases, on the apparatus.
16. The MAINS plug or an appliance coupler shall remain connected to the power source.
17. The airborne noise of the Apparatus does not exceed 70dB (A).
18. Apparatus with CLASS I construction shall be connected to a MAINS socket outlet with a protective earthing connection.
19. To reduce the risk of fire or electric shock, do not expose this apparatus to rain or moisture.
20. Do not attempt to modify this product. Doing so could result in personal injury and/or product failure.
21. Operate this product within its specified operating temperature range.



This symbol indicates that dangerous voltage constituting a risk of electric shock is present within this unit.



This symbol indicates that there are important operating and maintenance instructions in the literature accompanying this unit.

WARNING: This product contains a chemical known to the State of California to cause cancer and birth defects or other reproductive harm.

CONSIGNES DE SÉCURITÉ IMPORTANTES

1. LIRE ces consignes.
2. CONSERVER ces consignes.
3. OBSERVER tous les avertissements.
4. SUIVRE toutes les consignes.
5. NE PAS utiliser cet appareil à proximité de feu.
6. NETTOYER UNICAMENTE avec un chiffon sec.
7. NE PAS obstruer les ouvertures de ventilation. Laissez des distances suffisantes pour permettre une ventilation adéquate et effectuer l'installation en respectant les instructions du fabricant.
8. NE PAS installer à proximité d'une source de chaleur telle qu'une flamme nue, un radiateur, une bouche de chaleur, un poêle ou d'autres appareils (dont les amplificateurs) produisant de la chaleur. Ne placez aucune source à flamme nue sur le produit.
9. NE PAS désinstaller la sécurité de la fiche polarisée ou de la fiche de terre. Une fiche polarisée comporte deux lames dont l'une est plus large que l'autre. Une fiche de terre comporte deux lames et une troisième broche de mise à la terre. La lame la plus large ou la troisième broche assure la sécurité de l'utilisateur. Si la fiche fournie ne s'adapte pas à la prise électrique, demander à un électricien de remplacer la prise hors normes.
10. PROTÉGER le cordon d'alimentation afin que personne ne marche dessus et que rien ne le pince, en particulier au niveau des fiches, des prises de courant et du point de sortie de l'appareil.
11. UTILISER UNICAMENTE les accessoires spécifiés par le fabricant.
12. UTILISER uniquement avec un chariot, un pied, un trépied, un support ou une table spécifiés par le fabricant ou vendu avec l'appareil. Si un chariot est utilisé, déplacer l'ensemble chariot-appareil avec précaution afin de ne pas le renverser, ce qui pourrait entraîner des blessures.



13. DÉBRANCHER l'appareil pendant les orages ou quand il ne sera pas utilisé pendant longtemps.
14. CONFIER toute réparation à du personnel qualifié. Des réparations sont nécessaires si l'appareil est endommagé d'une façon quelconque, par exemple : cordon ou prise d'alimentation endommagés, liquide renversé ou objet tombé à l'intérieur de l'appareil, exposition de l'appareil à la pluie ou à l'humidité, appareil qui ne marche pas normalement ou que l'on a fait tomber.
15. NE PAS exposer cet appareil aux égouttes et aux éclaboussures. NE PAS poser des objets contenant de l'eau, comme des vases, sur l'appareil.
16. Le bruit du SECTEUR ou un coupleur d'appareil électrique doit rester facilement utilisable.
17. Le bruit aérien de l'appareil ne dépasse pas 70 dB (A).
18. L'appareil de construction de CLASSE I doit être raccordé à une prise SECTEUR dotée d'une protection par mise à la terre.
19. Pour réduire les risques d'incendie ou de choc électrique, ne pas exposer cet appareil à la pluie ou à l'humidité.
20. Ne pas essayer de modifier ce produit. Cela risque de causer des blessures et/ou la détérioration du produit.
21. Utiliser ce produit dans sa plage de températures de fonctionnement spécifiée.



Ce symbole indique la présence d'une tension dangereuse dans l'appareil constituant un risque de choc électrique.



Ce symbole indique que la documentation fournie avec l'appareil contient des instructions d'utilisation et d'entretien importantes.

INSTRUCCIONES IMPORTANTES DE SEGURIDAD

1. LEA estas instrucciones.
2. CONSERVE estas instrucciones.
3. PRESTE ATENCIÓN a todas las advertencias.
4. SIGA todas las instrucciones.
5. NO utilice este aparato cerca del agua.
6. LIMPIE UNICAMENTE con un tapo seco.
7. NO obstruya ninguna de las aberturas de ventilación. Deje espacio suficiente para proporcionar ventilación adecuada e instale los equipos según las instrucciones del fabricante.
8. NO instale el aparato cerca de fuentes de calor tales como llamas descubiertas, radiadores, registros de calefacción, estufas u otros aparatos (incluyendo amplificadores) que produzcan calor. No coloque artículos con llamas descubiertas en el producto.
9. NO anule la función de seguridad del enchufe polarizado o con clavija de puesta a tierra. Un enchufe polarizado tiene dos patas, una más ancha que la otra. Un enchufe con puestas a tierra tiene dos patas y una tercera clavija con puesta a tierra. La pata más ancha o la tercera clavija se proporciona para su seguridad. Si el tomacorriente no es del tipo apropiado para el enchufe, consulte a un electricista para que sustituya el tomacorriente de estilo anticuado.
10. PROTEJA el cable eléctrico para evitar que personas lo pisen o estropeen, particularmente en sus enchufes, en los tomacorrientes y en el punto en el cual sale del aparato.
11. UTILICE únicamente los accesorios especificados por el fabricante.
12. UTILICE únicamente con un carro, pedestal, trípode, escudera o mesa del tipo especificado por el fabricante o vendido con el aparato. Si se usa un carro, el mismo debe moverse con sumo cuidado para evitar que se vuelque con el aparato.



13. DESENCHUFE el aparato durante las tormentas eléctricas, o si no va a ser utilizado por un largo período.
14. TODA reparación debe ser llevada a cabo por técnicos calificados. El aparato requiere reparación si ha sufrido cualquier tipo de daño, incluyendo los daños al cordón o enchufe eléctrico, si se derrama líquido sobre el aparato o si caen objetos en su interior, si ha sido expuesto a la lluvia o a la humedad, si no funciona de modo normal, o si se ha caído.
15. NO exponga este aparato a chorros o salpicaduras de líquidos. NO coloque objetos llenos con líquido, tales como floreros, sobre el aparato.
16. El enchufe de alimentación o un acoplador para otros aparatos deberá permanecer en buenas condiciones de funcionamiento.
17. El nivel de ruido transmitido por el aire del aparato no excede de 70 dB(A).
18. Los aparatos de fabricación CLASE I deberán conectarse a un tomacorriente de ALIMENTACIÓN con clavija de puesta a tierra protectora.
19. Para reducir el riesgo de causar un incendio o sacudidas eléctricas, no exponga este aparato a la lluvia ni a humedad.
20. No intente modificar este producto. Hacerlo podría causar lesiones personales y/o la falla del producto.
21. Utilice este producto únicamente dentro de la gama de temperaturas de funcionamiento especificadas.



Este símbolo indica que la unidad contiene niveles de voltaje peligrosos que representan un riesgo de choque eléctrico.



Este símbolo indica que la literatura que acompaña a esta unidad contiene instrucciones importantes de funcionamiento y mantenimiento.

IMPORTANTES INSTRUÇÕES DE SEGURANÇA

1. LEIA estas instruções.
2. GUARDE estas instruções.
3. PRESTE ATENÇÃO a todas as instruções.
4. SIGA todas as instruções.
5. NÃO use este aparelho perto de água.
6. LIMPE SOMENTE com um pano seco.
7. NÃO bloqueie nenhuma das aberturas de ventilação. Deje distâncias suficientes para ventilação adequada e instale de acordo com as instruções do fabricante.
8. NÃO instale próximo de nenhuma fonte de calor, tais como fogo aceso, radiadores, bocais de aquecimento, fornos ou outros aparelhos que produzam calor (incluindo amplificadores). Não coloque fontes de chamas sobre o produto.
9. NÃO inutilize as características de segurança do conector polarizado ou com pino de aterramento. Um conector polarizado possui duas lâminas com uma mais larga do que a outra. Um conector com pino de aterramento possui duas lâminas e um terceiro pino de aterramento. E é fornecida uma lâmina mais larga ou o terceiro pino para sua segurança. Se por acaso o conector não se encaixar na tomada, chame um electricista para substituir a tomada obsoleta.
10. PROTEJA o cabo de alimentação, evitando que seja pisado ou que enroscue, especialmente nos conectores, nas tomadas elétricas e de emprego geral e no ponto onde elas saem do aparelho.
11. USE SOMENTE acessórios/apetrechos especificados pelo fabricante.
12. USE somente com um carrinho, pedestal, tripé, suporte ou mesa especificados pelo fabricante ou vendidos com o aparelho. Quando utilizar um carrinho, tenha cuidado ao movê-lo e o conjunto aparelho/carrinho para evitar danos com a queda do mesmo.



13. DESLIGUE este aparelho da tomada elétrica durante tempestades com relâmpagos ou quando não seja utilizado por longo período.
14. DEIXE toda a manutenção sob a responsabilidade de uma equipe de manutenção qualificada. É necessário realizar a manutenção quando por algum motivo o aparelho tiver sido danificado de alguma forma, como por exemplo por dano do cabo de alimentação elétrica ou do seu conector, por derramamento de líquido ou queda de objetos no aparelho, se o aparelho tiver sido exposto à chuva ou à umidade, não esteja operando normalmente ou tenha sofrido queda.
15. NÃO exponha o aparelho a respingos ou gotículas. NÃO coloque objetos cheios de líquidos, tais como vasos, sobre o aparelho.
16. O plugue MAINS (rede elétrica) ou um acoplador de aparelho deve estar sempre pronto para operação.
17. O ruído aéreo do Aparelho não ultrapassa 70 dB (A).
18. O aparelho com construção CLASSE I deve estar conectado à tomada da rede elétrica com ligação à terra.
19. Para reduzir o risco de incêndio ou choque elétrico, não exponha este aparelho à chuva ou umidade.
20. Não tente alterar este produto. Isso poderá resultar em lesão pessoal e/ou falha do produto.
21. Opere este produto dentro da faixa de temperatura de operação especificada.



Este símbolo indica que existe nesta unidade tensão perigosa que apresenta risco de choque elétrico.



Este símbolo indica que existem instruções de operação e manutenção importantes na literatura que acompanha esta unidade.

 **Caution**

For proper operation, set each transmitter to a different channel on the BLX88 receiver.



Consult your BLX Channel guide to select compatible channel sets.

 **Attention**

Pour un fonctionnement correct, régler chaque côté du récepteur double BLX88 sur un canal différent.



Consulter le guide des canaux BLX pour sélectionner des jeux de canaux compatibles.

 **Cuidado**

Para operação correta, ajuste cada lado do Receptor duplo BLX88 em um canal diferente.



Consulte o guia de Canal BLX para selecionar os ajustes de canais compatíveis.

 **Precaución**

Para el funcionamiento correcto, fije cada lado del receptor doble BLX88 en un canal diferente.



Consulte la guía de canales BLX para seleccionar los grupos de canales compatibles.

Quick Start Guide

1

a) Connect receiver to power source.
Brancher le récepteur à une source d'alimentation.
Den Empfänger an die Stromversorgung anschließen.
Conecte el receptor a la fuente de alimentación.

Collegate il ricevitore alla presa di alimentazione.
Conecte o receptor à fonte de alimentação.
Подключите приемник к источнику питания.

受信機を電源に接続します。
수신기를 전원에 연결합니다.
將接收机连接到电源。
Sambungkan receiver ke sumber daya.

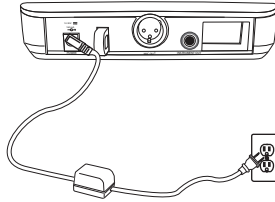

b)

Connect receiver to mixer or amplifier.
Hold power button to turn on.
Brancher le récepteur à un mélangeur ou un amplificateur. Appuyer sur le bouton d'alimentation pour allumer le récepteur.
Den Empfänger an das Mischpult oder den Verstärker anschließen. Die Taste power drücken, um den Empfänger einzuschalten.

Conecte el receptor a la mezcladora o amplificador. Oprima el botón de alimentación para encender el receptor.
Collegate il ricevitore al mixer o all'amplificatore. Premete il pulsante power per accendere il ricevitore.
Conecte o receptor ao mixer ou ao amplificador. Pressione o botão liga/desliga para ligar o receptor.

Подключите приемник к микшеру или усилителю. Чтобы включить приемник, нажмите кнопку Power.
受信機をミキサーまたはアンプに接続します。電源ボタンを押して受信機をオンにします。
수신기를 믹서나 앰프에 연결합니다. 전원 버튼을 눌러 수신기를 켭니다.
將接收机连接到混音器或放大器。按下电源按钮可打开接收机电源。
Sambungkan receiver ke mixer atau amplifier. Tekan tombol daya untuk menghidupkan receiver.

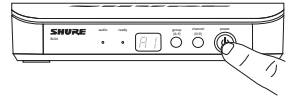
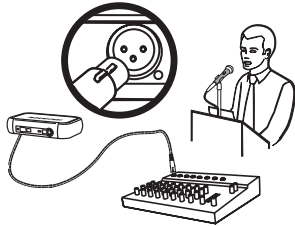

2

Press group button on receiver to perform a group scan.
Appuyer sur le bouton group du récepteur pour effectuer un balayage des groupes.
Am Empfänger die group-Taste drücken, um einen Gruppensuchlauf durchzuführen.
Oprima el botón de grupo en el receptor para realizar un escaneo de grupo.

Premete il pulsante group sul ricevitore per eseguire una ricerca del gruppo.
Pressione o botão group no receptor para executar uma procura de grupo.
Чтобы выполнить сканирование групп, нажмите на приемнике кнопку Group.

受信機のグループボタンを押して、グループスキャンを実行します。
그룹 스캔을 실행하려면 수신기의 그룹 버튼을 누릅니다.
按下接收机上的组按钮, 执行组扫描。
Tekan tombol grup pada receiver untuk memindai grup.

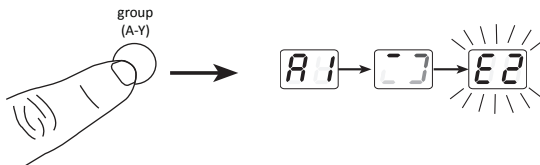

3

a)

Install batteries and turn on transmitter.

Installer les piles et allumer l'émetteur.

Die Batterien/Akkus einlegen und den Sender einschalten.

Instale las baterías y encienda el transmisor.

Installate le pile ed accendete il trasmettitore.

Instale as pilhas e ligue o transmissor.

Вставьте батарейки и включите передатчик.

送信機に電池を入れ、オンにします。

건전지를 설치한 다음 송신기를 켜십시오.

安裝電池并打开发射机电源。

Pasang baterai dan hidupkan pemancar.

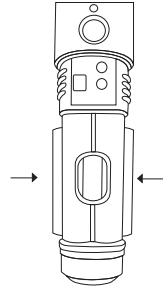
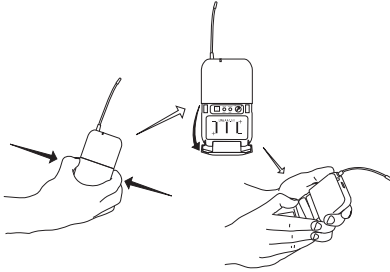

b)

On the transmitter, set the group and channel to match the receiver. The audio LED on the receiver should illuminate.

Sur l'émetteur, régler le groupe et le canal afin qu'ils correspondent à ceux du récepteur. Les barres RF et la LED des piles du récepteur doivent s'allumer.

Am Sender Gruppe und Kanal entsprechend der Empfängereinstellung einstellen. Auf dem Empfänger sollen die HF-Balken und Akku-LEDs aufleuchten.

En el transmisor, seleccione el grupo y canal para que coincidan con el receptor. Se deben iluminar las barras de RF y el LED de batería en el receptor.

Sul trasmettitore impostate il gruppo ed il canale corrispondenti a quelli del ricevitore. Le barre RF ed il LED della pila situati sul ricevitore devono illuminarsi.

Ligue o transmissor e ajuste o grupo e o canal para corresponder ao receptor. As barras de RF e o LED da pilha no receptor devem acender.

Установите на передатчике группу и канал для согласования с настройкой приемника. На приемнике должны загореться индикаторы интенсивности РЧ сигнала и светодиод батарейки.

送信機で、グループとチャンネルを設定して受信機に合わせます。受信機のRFバーと電池LEDが点灯します。

송신기에 그룹과 채널을 설정하여 수신기에 일치시키십시오. 수신기의 RF 바와 건전지 LED에 불이 들어와야 합니다.

在发射机上，将组和频道设置为与接收机匹配。接收机上的射频指示灯条和电池指示灯应点亮。

Pada pemancar, atur grup dan saluran untuk menyesuaikan dengan receiver. Bilah FR dan lampu LED baterai pada receiver harus menyala.



group



channel



group



If setting up additional systems, leave the first transmitter and receiver on. For each additional receiver, manually set the group to match the first receiver.

Note: The receiver will automatically perform a channel scan to find an available frequency after the group has been selected. Set the transmitter frequency to match the receiver.

Si l'on configure d'autres systèmes, laissez les premiers émetteur et récepteur allumés. Pour chaque système supplémentaire, réglez manuellement le groupe pour qu'il corresponde à celui du premier récepteur. Remarque : une fois le groupe sélectionné, le récepteur exécutera automatiquement un scan des canaux afin de trouver une fréquence disponible. Réglez la fréquence de l'émetteur pour qu'elle corresponde à celle du récepteur.

Falls weitere Systeme eingerichtet werden, den ersten Sender und Empfänger eingeschaltet lassen. Für jeden weiteren Empfänger die Gruppe manuell auf den ersten Empfänger einstellen. Hinweis: Der Empfänger führt automatisch einen Kanalscan durch, um nach der Auswahl der Gruppe eine verfügbare Frequenz zu finden. Die Senderfrequenz entsprechend der des Empfängers einstellen.

Si está configurando sistemas adicionales, deje encendidos el primer transmisor y receptor. Por cada receptor adicional, fije manualmente el grupo para hacerlo coincidir con el primer receptor. Nota: El receptor automáticamente realizará un escaneo de canales para encontrar una frecuencia disponible después que se ha seleccionado el grupo. Fije la frecuencia del transmisor para que coincida con el receptor.

Se impostate altri sistemi, lasciate accesi il primo trasmettitore e ricevitore. Per ciascun ricevitore aggiuntivo, impostate manualmente il gruppo in modo che corrisponda al quello del primo ricevitore. Nota: all'avvenuta selezione del gruppo il ricevitore esegue automaticamente una scansione del canale per individuare una frequenza disponibile. Impostate la frequenza del trasmettitore in modo che corrisponda a quella del ricevitore.

Ao configurar sistemas adicionais, deixe ligado o primeiro par de transmissor e receptor. Em cada receptor adicional, ajuste manualmente o grupo de acordo com o primeiro receptor. Observação: O receptor realizará automaticamente uma procura de canal para encontrar uma frequência disponível após a seleção do grupo. Ajuste a frequência do transmissor de acordo com o receptor.

Пр настройке дополнительных систем оставьте включенными первый передатчик и приемник. Для каждого дополнительного приемника вручную установите группу, соответствующую первому приемнику. Примечание. После выбора группы приемник автоматически выполнит сканирование каналов и найдет свободную частоту. Сопоставьте частоты передатчика и приемника.

追加システムを設定する場合は、最初の送信機と受信機をオンにした状態にしてください。各追加受信機ごとに、グループを手動で設定して最初の受信機に合わせてください。注記：受信機は自動的にチャンネルスキャンを実行し、グループを選択したら利用可能な周波数を検出します。送信機周波数を設定して受信機に一致させます。

추가 시스템을 설정하면 첫 번째 송신기와 수신기를 켜 상태로 두십시오. 각 추가 수신기마다 수동으로 첫 번째 송신기와 일치하는 그룹을 설정하십시오. 주: 그룹이 선택되면 수신기가 자동으로 채널 스캔을 수행하여 사용 가능한 주파수를 찾습니다. 송신기 주파수를 수신기에 일치시킵니다.

如果要设置更多的系统，应让第一台发射机和接收机保持在打开状态。对于每个增加的接收机，应将组手动设置为与第一台接收机匹配。注意：接收机可自动纸箱厂频道扫描，在选取组之后找到可用的频率。将发射机的频率设置为与接收机匹配。

Jika mengatur sistem tambahan, biarkan pemancar dan receiver pertama hidup. Untuk setiap receiver tambahan, atur grup secara manual untuk mencocokkan receiver pertama. Catatan: Receiver akan melakukan pemindaian saluran secara otomatis untuk mendapatkan frekuensi yang tersedia setelah grup dipilih. Atur frekuensi pemancar untuk mencocokkan receiver.

4

If sound is too faint or distorted, adjust the gain accordingly.

Si le son est trop faible ou distordu, réglez le gain en conséquence.

Falls der Ton zu schwach oder verzerrt ist, die Verstärkung dementsprechend korrigieren.

Si el sonido es demasiado débil o distorsionado, ajuste la ganancia según sea necesario.

Se il suono è troppo debole o distorto, regolate il guadagno di conseguenza.

Se o som estiver muito fraco ou distorcido, ajuste o ganho conforme necessário.

Если звук слишком слабый или искажен, подрегулируйте усиление.

音が小さすぎる場合や歪む場合は、ゲインを適宜調整してください。

사운드가 너무 흐리거나 왜곡된다면 게인을 조절하십시오.

如果声音太模糊或失真，应相应地调节增益设置。

Jika suara terlalu lemah atau terdistorsi, sesuaikan penguatan sesuai dengan itu.

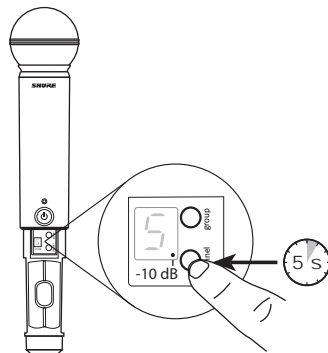
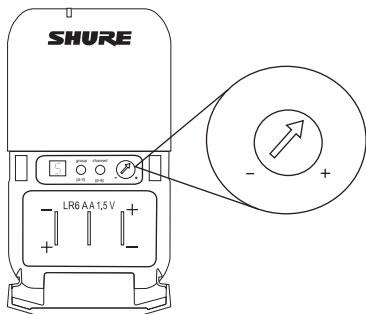

BLX

Features

Front Panel

BLX4

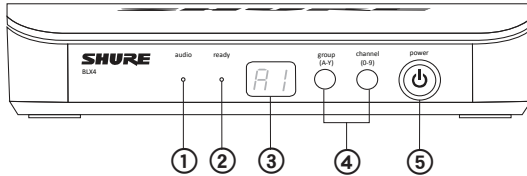

BLX88

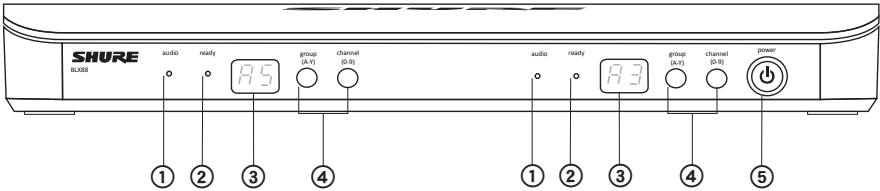

- | | |
|---|---|
| <p>① audio LED
Indicates strength of incoming audio signal: green for normal and red for overload.</p> <p>② ready LED
Green light indicates system is ready for use and receiving transmitter signal.</p> <p>③ LED Display
Displays group and channel setting.</p> | <p>④ group and channel Buttons
Scan: Push and release group button to scan for an open group and channel.
Manual: Push and hold group button to select a group. Push channel button to select a channel in the current group.</p> <p>⑤ power Button
Push and hold to turn power on or off.</p> |
|---|---|

Back Panel

BLX4

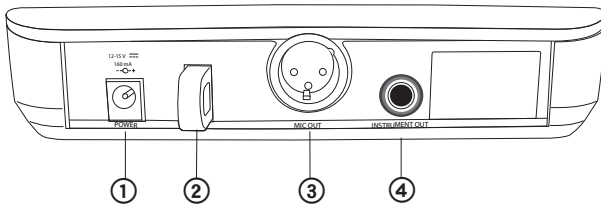

BLX88

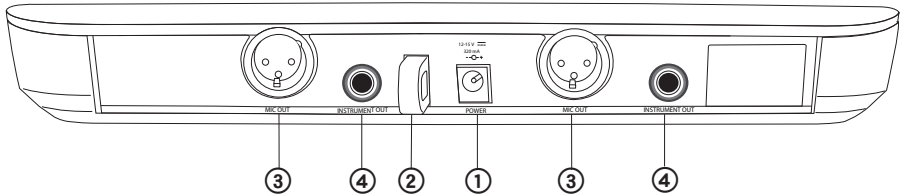

- ① DC Power Jack
- ② Adapter Cord Tie-Off
- ③ XLR microphone output jack (MIC OUT)
- ④ 6.35 mm (1/4") instrument level output jack (instrument out)

BLX1

- ① LED Indicator
Displays power and battery status (see Transmitter LED Indicators).
- ② power Switch
Toggles power on or off.
- ③ 4-Pin Microphone Input Jack (TA4 connector)
- ④ Antenna
- ⑤ group Button
Changes group setting.
- ⑥ LED Display
Displays group and channel setting.
- ⑦ channel Button
Changes channel setting.
- ⑧ Battery Compartment
- ⑨ Audio Gain Adjustment
Rotate to increase or decrease transmitter gain.

BLX1

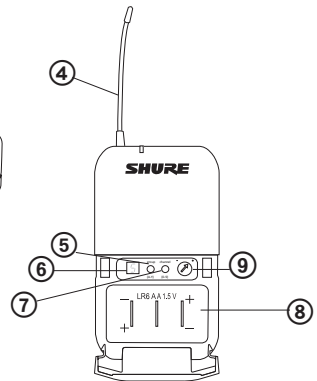
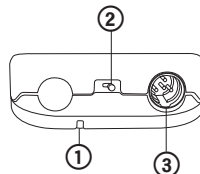

BLX2

- ① LED Indicator
Displays power and battery status (see Transmitter LED Indicators).
- ② power Button
Push to turn power on or off.
- ③ group Button
Changes group setting.
- ④ channel Button
Changes channel and gain setting.
- ⑤ LED Display
Displays group and channel setting.
- ⑥ Identification Cap
- ⑦ Battery Compartment

BLX2

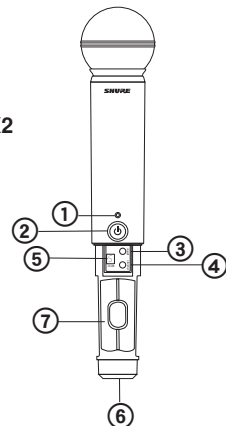

Transmitter LED Indicators

LED Indicator	Status
Green	Ready
Rapidly Flashing Red	Controls locked
Solid Red	Battery power low (less than 1 hour remaining*)
Flashing Red and shuts off	Batteries dead (change batteries to power on transmitter)

*For alkaline batteries only. For rechargeable batteries, solid red means the batteries are dead.

Single System Set Up

Before you begin, turn off all transmitters and turn on any equipment (other microphones or personal monitoring systems) that could cause interference during the performance.

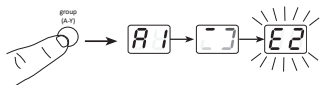

1. Press and release the **group** button on the receiver.
The receiver scans for the clearest group and channel.
Note: If you want to stop the scan, push the **group** button again.
2. Turn on transmitter and change the group and channel to match the receiver (See Setting Transmitter Group and Channel).
Once the system is set up, perform an audio check and adjust the gain if necessary.

Setting Transmitter Group and Channel

Transmitter group and channel must be manually set to match the receiver.

Group (letter)

1. Press and release the **group** button on the transmitter to activate the display. Press the **group** button again and the display flashes.
2. While the display is flashing, press the **group** button again to advance to the desired group setting.

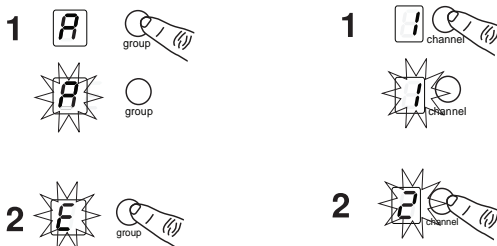
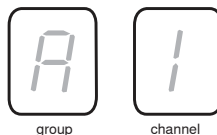

Channel (number)

If channel needs to be changed, follow the same procedure using the **channel** button instead of the **group** button.

Note:

- When the group and channel correctly match the receiver, the **ready** LED on receiver illuminates.
- After manual setup, the transmitter alternately displays the group and channel setting for about two seconds.

Multiple System Setup

Up to 12 systems can operate simultaneously (band and RF environment dependent).

Important: Set up each system one-at-a-time. Once a receiver and transmitter are tuned to the same group and channel, leave the transmitter powered on. Otherwise, scans from the other receivers will not detect that channel as occupied. For the BLX88, be sure to setup both transmitters before progressing to the next receiver.

Turn **on** any other equipment that could cause interference during the performance so it will be detected during the group and channel scans in the following steps.

Before you begin system set up, turn all receivers **ON** and all transmitters **OFF**.

For the first receiver:

1. Perform a group scan.

This finds the group with the most clear channels.

Note: For the BLX88, the group scan sets up both receivers at the same time.

2. Turn on the first transmitter and change the group and channel to match receiver.
3. Leave the transmitter on and continue with the additional systems.

Note: If the selected group does not contain enough open channels, manually select group "a" when setting up larger systems.

For each additional receiver:

1. Use manual setup to change the receiver to match the group setting of the first receiver. Recall that each time the group setting is changed, a channel scan is automatically done.
2. Turn on the transmitter and change the group and channel to match the receiver.
3. Leave the transmitter on and continue to the next system.
4. Once all receivers are set up, perform an audio check on all microphones.

Manually Setting Receiver Group and Channel

The receiver group may need to be changed as part of a multiple system setup.

Group (letter)

1. Hold the **group** button on the receiver until the display begins to flash.
2. While the display is flashing, press the **group** button again to advance to the next group.

Note: Only the group setting will be displayed during the manual setup.

3. Once the desired group is reached, release the **group** button. The receiver automatically performs a channel scan.

Channel (number)

Always use a channel selected by the channel scan. However, if necessary, the channel can be set manually. Follow the same steps above using the **channel** button instead of the **group** button.

Locking and Unlocking Controls

Lock system controls to prevent accidental setting changes or power off.

Transmitter (lock/unlock)

Turn the transmitter on. Hold the **group** button, then press the **channel** button for approximately 2 seconds. The LED indicator rapidly flashes red when locked.

Receiver (lock/unlock)

Turn the receiver on. Simultaneously hold the **group** and **channel** button. The display flashes rapidly.

- When locked, the display flashes rapidly if any key is pressed.
- The BLX88 locks on both sides when locked from either side.

Tips to Improve Wireless System Performance

If you encounter interference or dropouts, try the following suggestions:

- Choose a different receiver channel
- Reposition the receiver so there is nothing obstructing a line of sight to the transmitter (including the audience)
- Avoid placing transmitter and receiver where metal or other dense materials may be present
- Move the receiver to the top of the equipment rack
- Remove nearby sources of wireless interference, such as cell phones, two-way radios, computers, media players, Wi-Fi devices, and digital signal processors
- Charge or replace the transmitter battery
- Keep transmitters more than two meters (6 feet) apart
- Keep the transmitter and receiver more than 5 meters (16 feet) apart
- During sound check, mark trouble spots and ask presenters or performers to avoid those areas

Getting Good Sound

Correct Microphone Placement

- Hold the microphone within 12 inches from the sound source. For a warmer sound with increased bass presence, move the microphone closer.
- Do not cover grille with hand.

Wearing the Headworn Microphone

- Position the headworn microphone 13 mm (1/2 in.) from the corner of your mouth.
- Position lavalier and headworn microphones so that clothing, jewelry, or other items do not bump or rub against the microphone.

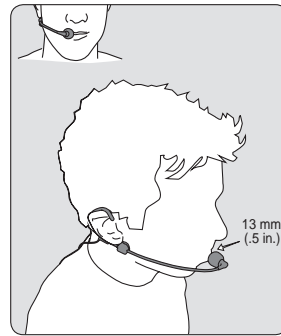

Adjusting Gain

Monitor the **audio** LED indicator on the receiver front panel when setting the transmitter gain.

- **Green:** normal levels
- **Red:** excessive sound levels (overload).

The red LED should only illuminate infrequently when you speak loudly or play your instrument loudly.

BLX1

Rotate the audio gain adjustment to increase (+) or decrease (-) the gain until desired level is reached.

For instruments, turn gain to minimum setting. For lavaliers, increase the gain as desired.

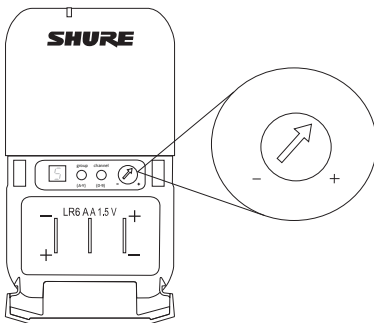

BLX2

The BLX2 features two gain level settings, default and attenuated (-10 dB). The default setting is used for most situations. If the receiver **audio** LED flickers red often, set the microphone to attenuated. Use the **channel** button to change the gain setting.

1. Hold down the **channel** button for 5 seconds. A dot appears on the lower right-hand corner of the LED display, which indicates -10 dB gain setting has been activated.
2. To change the gain back to default, hold the **channel** button again for 5 seconds, or until the dot disappears.

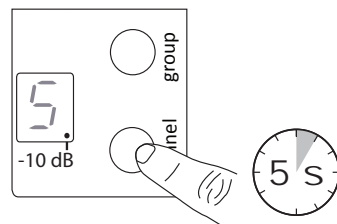

Batteries

Expected life for AA batteries is up to 14 hours (total battery life varies depending upon battery type and manufacturer).

When the LED indicator turns red, it signifies "low battery" with approximately 60 minutes of remaining battery life.

For alkaline batteries only. For rechargeable batteries, solid red means the batteries are dead.

To remove batteries from the handheld transmitter, push them out through the opening in the microphone battery compartment.



WARNING: Danger of explosion if battery incorrectly replaced. Operate only with Shure compatible batteries.



WARNING: Battery packs shall not be exposed to excessive heat such as sunshine, fire, or the like.

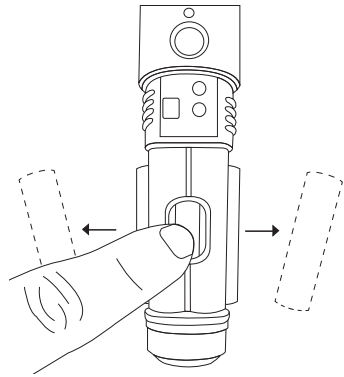

Wearing the Bodypack Transmitter

Clip the transmitter to a belt or slide a guitar strap through the transmitter clip as shown.

For best results, the belt should be pressed against the base of the clip.

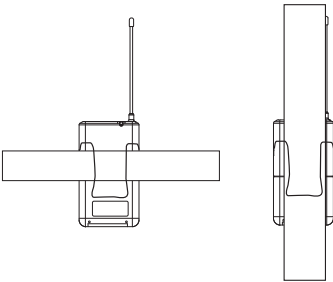

Power Off

Hold down the **power** button to power off the BLX2 or BLX4/88. To power off the BLX1, slide the power toggle switch to OFF.

Removing and Installing Identification Caps

The BLX2 is equipped with a black identification cap from the factory (dual vocal systems ship with additional gray cap).

To remove: Remove battery cover. Squeeze sides and pull off cap.

To install: Align the cap and click into place. Replace battery cover.

An Identification Cap Kit containing assorted colored caps is available as an optional accessory.

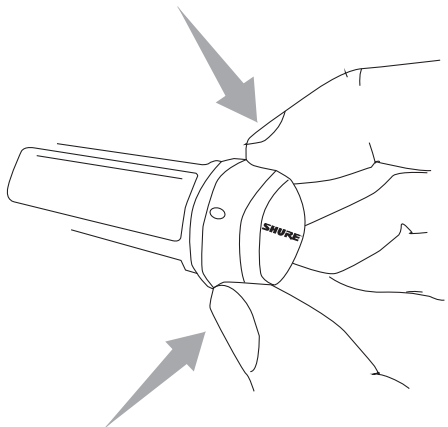

Troubleshooting

Issue	Indicator Status	Solution
No sound or faint sound	Receiver ready LED on	<ul style="list-style-type: none"> • Verify all sound system connections or adjust gain as needed (see Adjusting Gain) • Verify that the receiver is connected to mixer/ amplifier
	Receiver ready LED off	<ul style="list-style-type: none"> • Turn on transmitter • Make sure the batteries are installed correctly • Perform transmitter setup (see Single System Setup) • Insert fresh batteries
	Receiver LED screen off	<ul style="list-style-type: none"> • Make sure DC adapter is securely plugged into electrical outlet. • Make sure receiver is powered on.
	Transmitter indicator LED flashing red	Replace transmitter batteries (see Changing Batteries).
Audio artifacts or dropouts	Ready LED flickering or off	<ul style="list-style-type: none"> • Change receiver and transmitter to a different group and/or channel. • Identify nearby sources of RF interference, and shutdown or remove source. • Replace transmitter batteries. • Ensure that receiver and transmitter are positioned within system parameters • System must be set up within recommended range and receiver kept away from metallic surfaces. • Transmitter must be used in line of sight from receiver for optimal sound
Distortion	Audio LED on receiver indicates overload (red)	Reduce transmitter gain (see Adjusting Gain).
Sound level variations when switching to different sources	N/A	Adjust transmitter gain as necessary (see Adjusting Gain).
Receiver/transmitter won't turn off	LED/display flashing rapidly	See Locking and Unlocking Controls.

BLX

Working Range

91 m (300 ft) Line of Sight

Note: Actual range depends on RF signal absorption, reflection and interference.

Audio Frequency Response

50 to 15,000 Hz

Note: Dependent on microphone type

Total Harmonic Distortion

Ref. ± 33 kHz deviation with 1 kHz tone

0.5%, typical

Dynamic Range

100 dB, A-weighted, typical

Operating Temperature

-18°C (0°F) to 57°C (135°F)

Note: Battery characteristics may limit this range.

Polarity

Positive pressure on microphone diaphragm (or positive voltage applied to tip of WA302 phone plug) produces positive voltage on pin 2 (with respect to pin 3 of low-impedance output) and the tip of the 1/4-inch output.

BLX1

Audio Input Level

gain	max	-16 dBV maximum
	min (0 dB)	+10 dBV maximum

Gain Adjustment Range

26 dB

Input Impedance

1 M Ω

RF Transmitter Output

10 mW, typical

varies by region

Dimensions

110 mm x 64 mm x 21 mm (H x W x D)

Weight

75 g (2.6 oz.), without batteries

Housing

Molded ABS

Power Requirements

2 LR6 AA batteries, 1.5 V, alkaline

Battery Life

up to 14 hours (alkaline)

BLX2

Audio Input Level

gain	0dB	-20 dBV maximum
	-10dB	-10 dBV maximum

Gain Adjustment Range

10 dB

RF Transmitter Output

10 mW, typical

varies by region

Dimensions

224 mm X 53 mm dia. (8 7/8 X 2 1/8 in.)

Weight

218 g (7.7 oz.) (without batteries)

Housing

Molded ABS

Power Requirements

2 LR6 AA batteries, 1.5 V, alkaline

Battery Life

up to 14 hours (alkaline)

BLX4 & BLX88

Output Impedance

XLR connector	200 Ω
6.35 mm (1/4") connector	50 Ω

Audio Output Level

Ref. ± 33 kHz deviation with 1 kHz tone

XLR connector	-27 dBV (into 100 k Ω load)
6.35 mm (1/4") connector	-13 dBV (into 100 k Ω load)

RF Sensitivity

-105 dBm for 12 dB SINAD, typical

Image Rejection

>50 dB, typical

Dimensions

BLX4	40 mm X 188 mm X 103 mm (H x W x D)
BLX88	40 mm X 388 mm X 116 mm (H x W x D)

Weight

BLX4	241 g (8.5 oz.)
BLX88	429 g (15.1 oz.)

Housing

Molded ABS

Power Requirements

12-15 V DC @ 160 mA (BLX88, 320 mA), supplied by external power supply (tip positive)

Important Product Information

Certifications

This product meets the Essential Requirements of all relevant European directives and is eligible for CE marking. The CE Declaration of Conformity can be obtained from Shure Incorporated or any of its European representatives. For contact information please visit www.shure.com

The CE Declaration of Conformity can be obtained from: www.shure.com/europe/compliance

Authorized European representative:
Shure Europe GmbH
Headquarters Europe, Middle East & Africa
Department: EMEA Approval
Jakob-Dieffenbacher-Str. 12
75031 Eppingen, Germany
Phone: 49-7262-92 49 0
Fax: 49-7262-92 49 11 4
Email: EMEAsupport@shure.de

BLX1, BLX2

Certified under FCC Part 74.

Certified by IC in Canada under RSS-123 and RSS-102.

FCC ID: DD4BLX1A, DD4BLX1B, DD4BLX1C, DD4BLX1D; DD4BLX2A, DD4BLX2B, DD4BLX2C, DD4BLX2D. **IC:** 616A-BLX1A, 616A-BLX1B, 616A-BLX1C, 616A-BLX1D; 616A-BLX2A, 616A-BLX2B, 616A-BLX2C, 616A-BLX2D

BLX4, BLX88

Approved under the Declaration of Conformity (DoC) provision of FCC Part 15.

Band	Range	Output Power
H8E	518 to 542 MHz	10 mW
K3E	606 to 630 MHz	10 mW
K14	614 to 638 MHz	10 mW
M17	662 to 686 MHz	10 mW
Q25	742 to 766 MHz	10 mW
R12	796 to 806 MHz	10 mW
S8	823 to 832 MHz	10 mW
T11	863 to 865 MHz	10 mW

NOTE: This Radio equipment is intended for use in musical professional entertainment and similar applications. This Radio apparatus may be capable of operating on some frequencies not authorized in your region. Please contact your national authority to obtain information on authorized frequencies and RF power levels for wireless microphone products.

Australia Warning for Wireless

This device operates under an ACMA class licence and must comply with all the conditions of that licence including operating frequencies. Before 31 December 2014, this device will comply if it is operated in the 520-820 MHz frequency band. **WARNING:** After 31 December 2014, in order to comply, this device must not be operated in the 694-820 MHz band.

LICENSING INFORMATION

Licensing: A ministerial license to operate this equipment may be required in certain areas. Consult your national authority for possible requirements. Changes or modifications not expressly approved by Shure Incorporated could void your authority to operate the equipment. Licensing of Shure wireless microphone equipment is the user's responsibility, and licensability depends on the user's classification and application, and on the selected frequency. Shure strongly urges the user to contact the appropriate telecommunications authority concerning proper licensing, and before choosing and ordering frequencies.

Information to the user

This equipment has been tested and found to comply with the limits for a Class B digital device, pursuant to Part 15 of the FCC Rules. These limits are designed to provide reasonable protection against harmful interference in a residential installation. This equipment generates uses and can radiate radio frequency energy and, if not installed and used in accordance with the instructions, may cause harmful interference to radio communications. However, there is no guarantee that interference will not occur in a particular installation. If this equipment does cause harmful interference to radio or television reception, which can be determined by turning the equipment off and on, the user is encouraged to try to correct the interference by one or more of the following measures:

- Reorient or relocate the receiving antenna.
- Increase the separation between the equipment and the receiver.
- Connect the equipment to an outlet on a circuit different from that to which the receiver is connected.
- Consult the dealer or an experienced radio/TV technician for help.

This device complies with Industry Canada licence-exempt RSS standard(s). Operation of this device is subject to the following two conditions: (1) this device may not cause interference, and (2) this device must accept any interference, including interference that may cause undesired operation of the device.

Le présent appareil est conforme aux CNR d'Industrie Canada applicables aux appareils radio exempts de licence. L'exploitation est autorisée aux deux conditions suivantes : (1) l'appareil ne doit pas produire de brouillage, et (2) l'utilisateur de l'appareil doit accepter tout brouillage radioélectrique subi, même si le brouillage est susceptible d'en compromettre le fonctionnement.

This Class B digital apparatus complies with Canadian ICES-003. Cet appareil numérique de la classe B est conforme à la norme NMB-003 du Canada.

Note: EMC conformance testing is based on the use of supplied and recommended cable types. The use of other cable types may degrade EMC performance.

Changes or modifications not expressly approved by the manufacturer could void the user's authority to operate the equipment.

Please follow your regional recycling scheme for batteries, packaging, and electronic waste.

PERU DECLARATION OF CONFORMITY

Shure Incorporated
5800 W. Touhy Avenue
Niles, Illinois 60714-4608, U.S.A.
(847) 600-2000

Shure Incorporated declares that the following product

Model: BLX1-H8E (518 – 542 MHz) BLX1-K3E (606 – 630 MHz)

Description: UHF FM Wireless Microphone Transmitter

Has been tested and found to comply with the limits set in Peru wireless regulatory standard **RM N° 204-2009-MTC/03**. It's effective radiated power (ERP) has been measured to be less than 10 mW, as measured in accordance with ETSI standard EN 300 422.

Signed  Date: May 16, 2012

Name, Title: Alex Chung, Sr. Manager, Global Compliance, Shure Incorporated

PERU DECLARATION OF CONFORMITY

Shure Incorporated
5800 W. Touhy Avenue
Niles, Illinois 60714-4608, U.S.A.
(847) 600-2000

Shure Incorporated declares that the following product

Model: BLX2-H8E (518 – 542 MHz) BLX2-K3E (606 – 630 MHz)

Description: UHF FM Wireless Microphone Transmitter

Has been tested and found to comply with the limits set in Peru wireless regulatory standard **RM N° 204-2009-MTC/03**. It's effective radiated power (ERP) has been measured to be less than 10 mW, as measured in accordance with ETSI standard EN 300 422.

Signed  Date: May 16, 2012

Name, Title: Alex Chung, Sr. Manager, Global Compliance, Shure Incorporated



United States, Canada, Latin America, Caribbean:

Shure Incorporated
5800 West Touhy Avenue
Niles, IL 60714-4608 USA

Phone: +1-847-600-2000
Fax: +1-847-600-1212 (USA)
Fax: +1-847-600-6446
Email: info@shure.com

www.shure.com

Europe, Middle East, Africa:

Shure Europe GmbH
Jakob-Dieffenbacher-Str. 12,
75031 Eppingen, Germany

Phone: +49-7262-92490
Fax: +49-7262-9249114
Email: info@shure.de

Asia, Pacific:

Shure Asia Limited
22/F, 625 King's Road
North Point, Island East
Hong Kong

Phone: 852-2893-4290
Fax: 852-2893-4055
Email: info@shure.com.hk